



MB42CH-S/M.10

MB63CH-S/M.10

**Pro Flush Series Distribution Box
User Manual**



Date: May 30, 2019

Version: V1.0.0

Overview

Pro Flush Series Distribution Box, which is convenient to install and excellent in structure, adopts modularized design with aluminum alloy bottom frame. Customizable knockouts enables fast wiring according to the external environment. The Distribution Box is applicable for residence or office building with smart devices.



Pro Flush (42CH)



Pro Flush XL (63CH)

Components

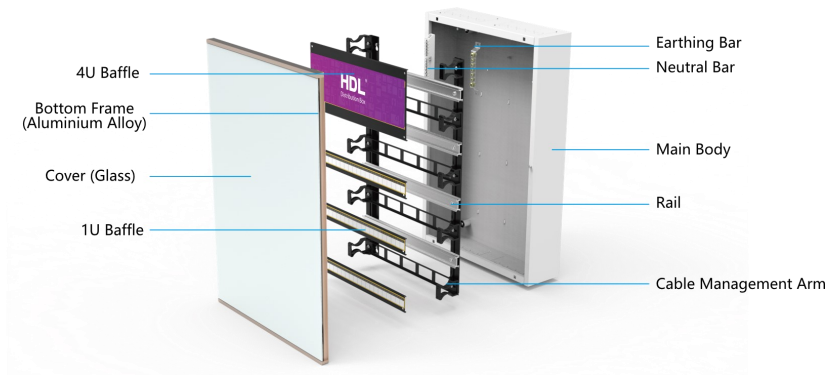

Dimensions—Pro Flush

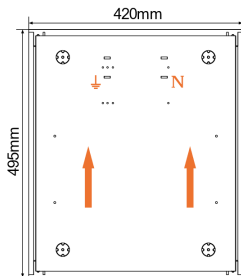
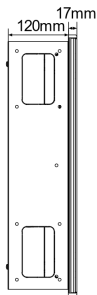
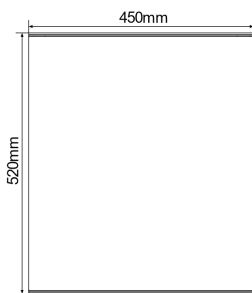

Overall: 520×450×137mm

Cover: 520×450×17mm

Main Body: 495×420×120mm

Dimensions—Pro Flush XL

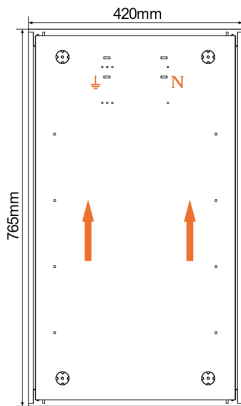
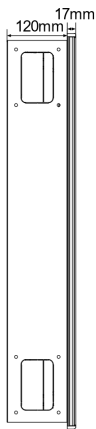
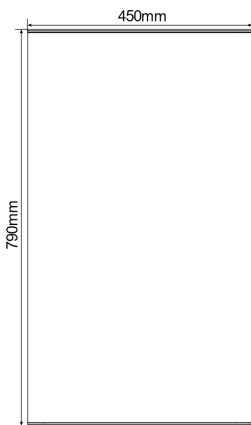

Overall: 790×450×137mm

Cover: 790×450×17mm

Main Body: 765×420×120mm

Installation

1. The Distribution Box can be flush mounted only, and modules with Buspro/KNX/RS485/LonWorks can be installed on the rails in the Distribution Box.
2. The distance between the rails can be adjusted for installing modules with different dimensions.
3. The Distribution Box (without the cover) should be on the same surface with the wall and must not be higher than the wall surface.
4. The cover and the main body of the Distribution Box can be divided, and the cover should be installed after house renovation. So the main body should be protected during the renovation to avoid pollution, and the cover, together with other accessories, should be carefully reserved.
5. The Distribution Box is top/bottom feed and can be customized for other wiring requirements.

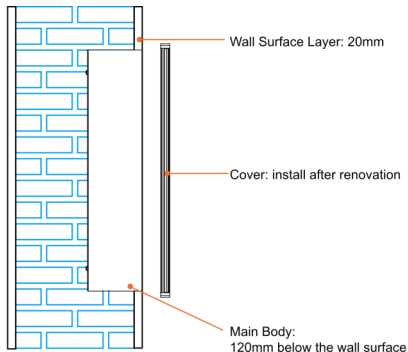

Dividable Interiors

In order to reduce wiring time, the rails, slide rails and cable manage arms can be divided with the main body.

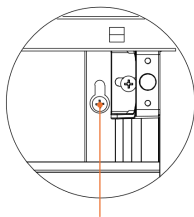
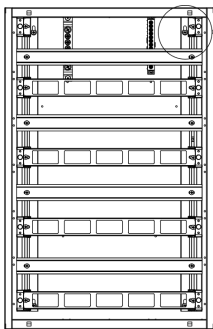

Unscrew 4 screws on the pillars to divide interiors with the main body.

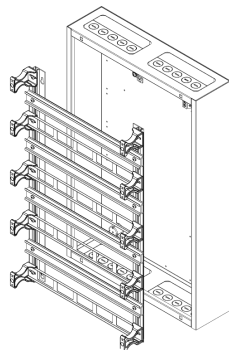

Slide Rail Adjustment

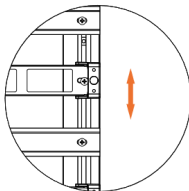
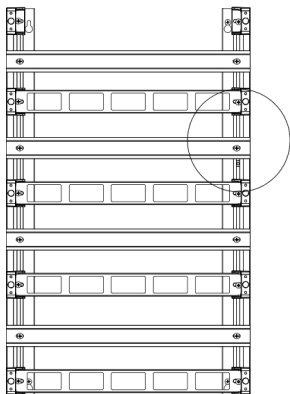

Unscrew to adjust rail distance to install modules with different dimensions.

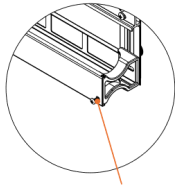

Magnet lock for the cover can be fixed with M4 screws.

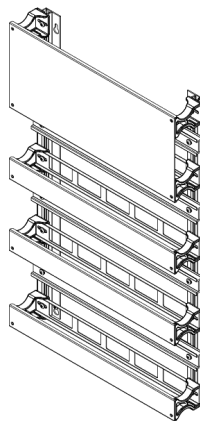

Cover Installation

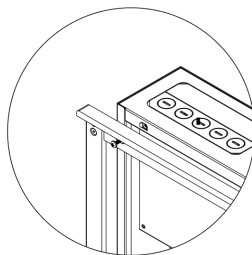
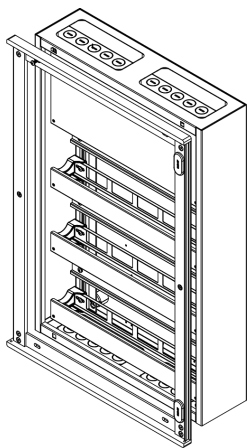

Fixed with M5X16 screws and M5 nuts

Baffle Installation

Baffles, applicable for standard modules, are not included in the package list.

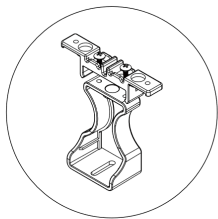
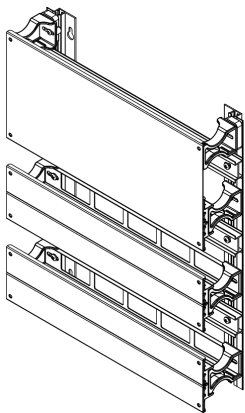

Fix with M4 tapping screws.

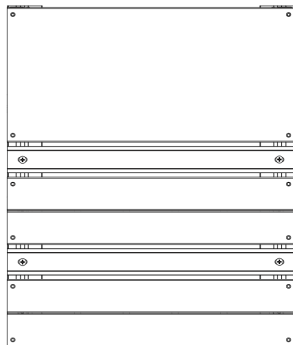

Distribution Box Combination

1. Two or more distribution boxes can be combined vertically, as shown below.
2. 4 connectors (not provided) are required for combination, and should be fixed with 16 M5×8 screws.
3. It is recommended to open the knockouts before the combination for wiring.

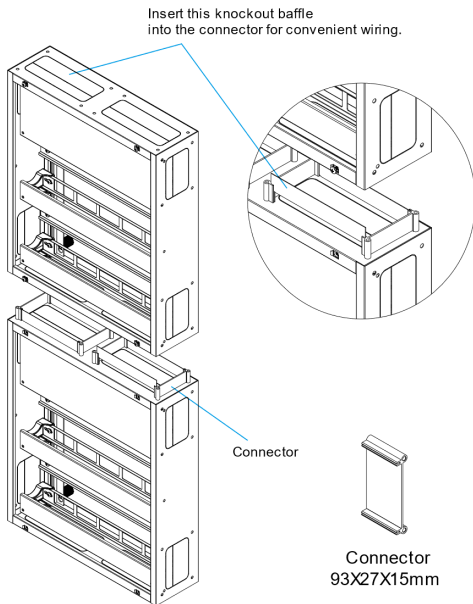

Package List

Components	Pro Flush	Pro Flush XL
Cover	1	1
Main Body	1	1
Slide Rail	2	2
Cable Management Arm	2	3
1U Baffle	2	3
3U Baffle	1	/
4U Baffle	/	1
Rail	3	4
Screw	Several	Several

Note: 4U baffle of Pro Flush XL can be replaced with 3U baffle in order for one more rail and cable management arm, please inform us in advance if this is needed.



HDL Automation Co., Ltd.

Technical support

E-mail: support@hdlautomation.com

Website: <https://www.hdlautomation.com>

©Copyright by HDL Automation Co., Ltd. All rights reserved.
Specifications subject to change without notice.