

HDL[®]



DEMO CASES

Control Panels

A Portable Way To Showcase The Panels.

HDL provides the market with various categories of smart panels that can be used in homes, commercial buildings and hotels. To make it easier for you to showcase these beautiful panels on more occasions, we now offer you two Demo Cases of control panels.



Residential



Commercial



Hospitality



Tile Series Panel Demo Case

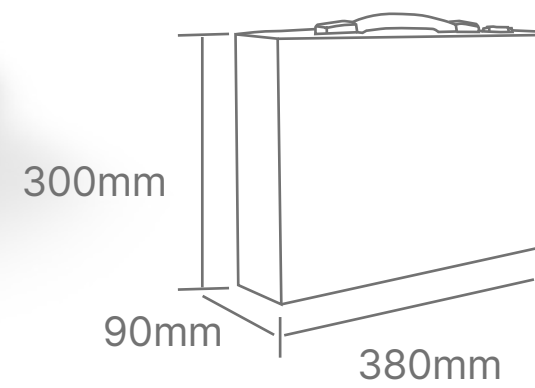

Weight: 4KG



Control Panel Demo Case

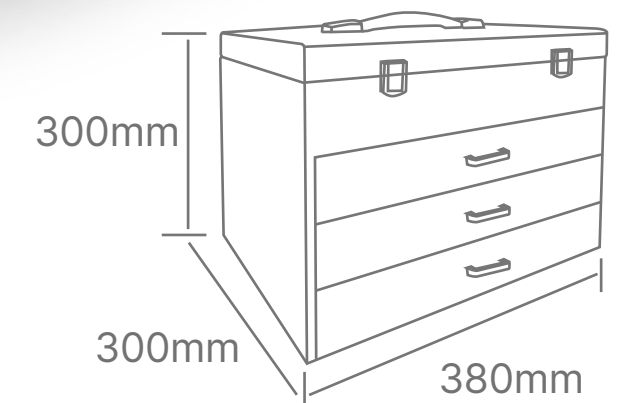

Weight: 10.25KG



Lighting



Temperature



Shading



Audio/ Video



Security



Scene Control



Automatic Control

These cases are designed to be highly portable and present a sense of high quality with its leather finish. One is for the Tile series panels. And the other for the remaining best-selling panels. It is perfectly suitable for a makeshift exhibition, business meeting at the customer's office and other occasions on the go.

Grab a case and get on your business trip!



Customer's Office



Business Meeting



Makeshift Exhibition



Other Occasions

Tile Series Panel Demo Case

Tile is a series of intelligent control panels that can well meet your requirement with its multi-functional features. The demo case is carefully planned to demonstrate various functions, materials, and colors of Tile Series.

- Lighting
- Temperature
- Shading
- Audio/ Video
- Security
- Scene Control
- Automatic Control



3-Gang

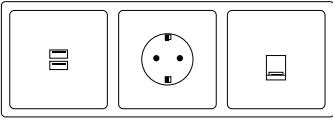

- Tile / Dual USB Charger Wall Outlet
- Tile / EU Panel
- Tile 1 Port Cable TV Wall Plate (CATV)

● Space Gray

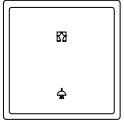

- Tile Series 1 Button Panel B
- Ivory White

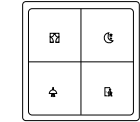

- Tile Series 4 Buttons Panel A
- Ash Gray



- Tile Series Climate Panel (Plastic Version)
- Champagne Gold



Control Panel Demo Case

In this four-layer control panel demo case, we show all kind of HDL panels, including touch display panels, touch panels and push-button panels. Every detail embodies the warm design intention of providing you with the comfortable tactility and experience.

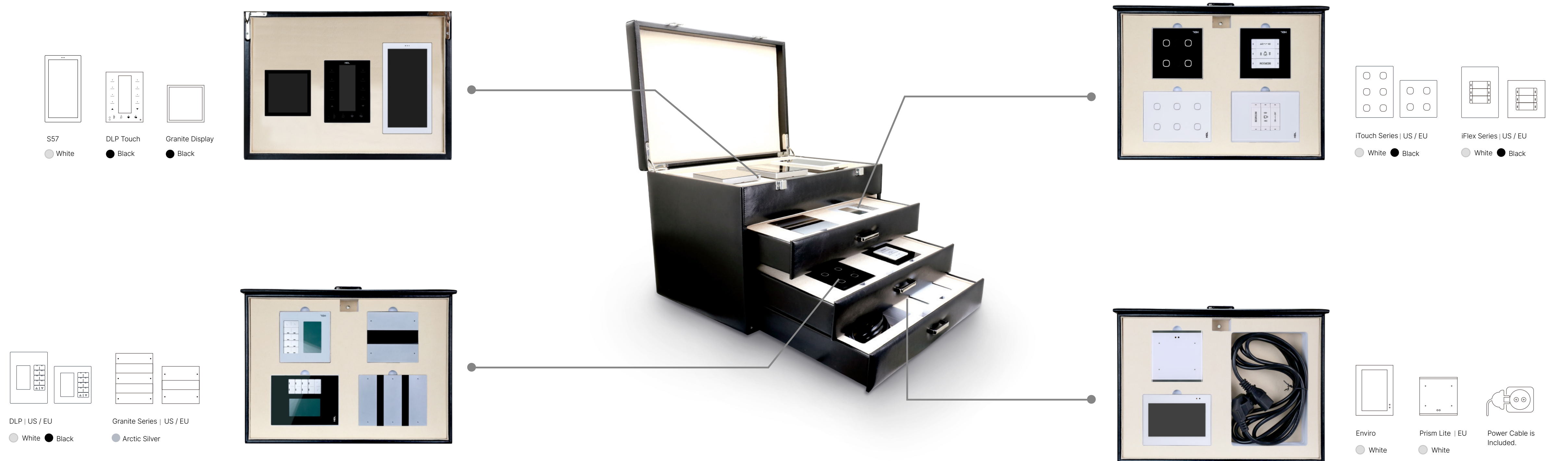

Device LIST

Tile Series Panel Demo Case

• Panel Power Interface EU	x 3	HDL-MPPI/TILE.48
• 750Ma Power Supply	x 1	HDR-15-24
• Tile Series 4 Buttons Smart Panel EU	x 1	HDL-MP4B/TILE.48
• Tile Series Climate Panel (Plastic Version)	x 1	HDL-MPL40E/TILE.48
• Tile Dual USB Charger Wall Outlet	x 1	HDL-MP2-W-USB/TILE.48
• Tile EU Socket	x 1	HDL-MP1-S-EU/TILE.48
• Tile 1 Port Toslink Wall Plate	x 1	HDL-MP1-W-CATV/TILE.48
• Tile Series 2 Buttons Smart Panel EU	x 1	HDL-MP2S/TILE.48

Control Panel Demo Case

• Panel Power Interface EU	x 2	HDL-MPLPI.48-A
• WI S57 5.7 Inch Touch Screen	x 1	HDL-MTS57.1
• 750Ma Power Supply	x 1	HDR-15-24
• Granite Display Panel EU	x 1	HDL-MPTL4C.48
• 4.3 inch Enviro Touch Screen	x 1	HDL-MPTLC43.46-A
• Granite Series 4 Buttons Smart Panel EU	x 1	HDL-MP4C.48
• Granite Series 6 Buttons Smart Panel US	x 1	HDL-MP6C.46
• Modern Series DLP Smart Panel EU	x 1	HDL-MPL8.48-A
• Modern Series DLP Smart Panel US	x 1	HDL-MPL8.46-A
• iTouch Series 4 Buttons Touch Panel EU	x 1	HDL-MPT4.48-A
• iTouch Series 6 Buttons Touch Panel US	x 1	HDL-MPT6.46-A
• iFlex Series 6 Buttons Smart Panel EU	x 1	HDL-MP6B.48-A
• iFlex Series 8 Buttons Smart Panel EU	x 1	HDL-MP8B.48-A
• Prism Lite 4 Buttons Touch Panel EU	x 1	HDL-MPTF04.48
• Modern Series DLP Touch Panel US	x 1	HDL-MPTL14.46-A

Smart PANELS

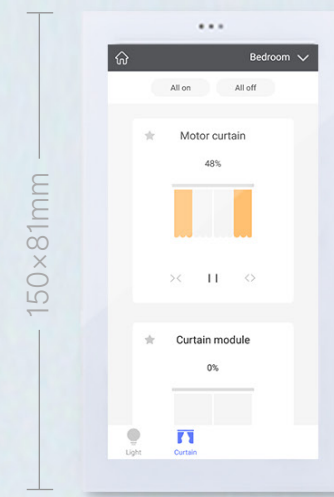

150x81mm

S57

● White ● Black



86x86mm

Granite Display

● White ● Black



86x86mm

iFlex Series | EU / SU

2-Button / 4-Button / 6-Button / 8-Button

● White ● Black



86x86mm

Granite Series

EU / US

● Arctic Silver ● Space Gray
● Rose Gold

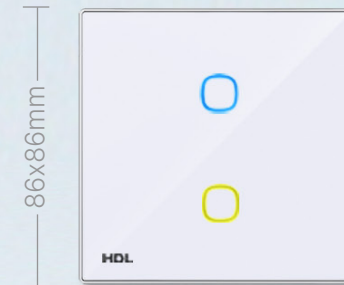

86x86mm

iTouch Series | EU / US

2-Button / 4-Button / 6-Button

● White ● Black



116.4x86mm

DLP Touch

● White ● Black

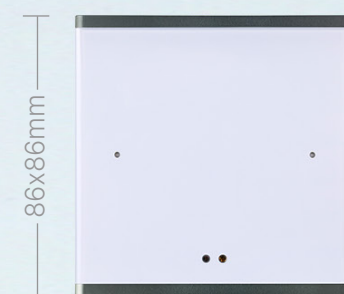

86x86mm

Prism Lite | EU / US

2-Button / 4-Button / 6-Button

● Pearl White ● Night Black

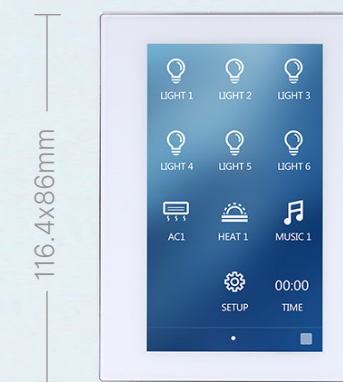

116.4x86mm

Enviro

● White ● Black

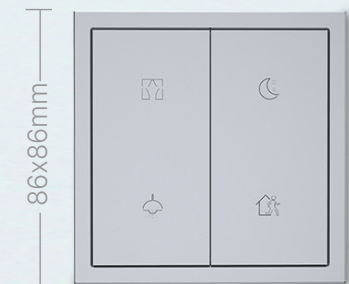

86x86mm

Tile Series

2-Gang / 3-Gang / 4-Gang

Plastic:

● Ivory White ● Ash Gray

Metal:

● Champagne Gold ● Space Gray



116.4x86mm

Prism Pro

● Pearl White ● Night Black



86x86mm

DLP | EU / SU

● White ● Black

Tile Series

CONTROL PANEL

Tile is a series of intelligent control panels that has push-button keypads, OLED multifunctional panels, socket panels with USB ports and emergency button panel.

Its rectangular or square buttons are just like little tiles paved on the surface. It is able to keep the walls in a consistent and beautiful look while meeting various requirements of functionality.

Flexible combinations for functionality

The basic unit of Tile is a keypad or socket panel in EU standard. You can use just one unit if it meets your requirement, or combine multiple units to serve more functionality in a specific area.

Color:

Plastic: ● Ivory White ● Ash Gray Metal: ● Champagne Gold ● Space Gray

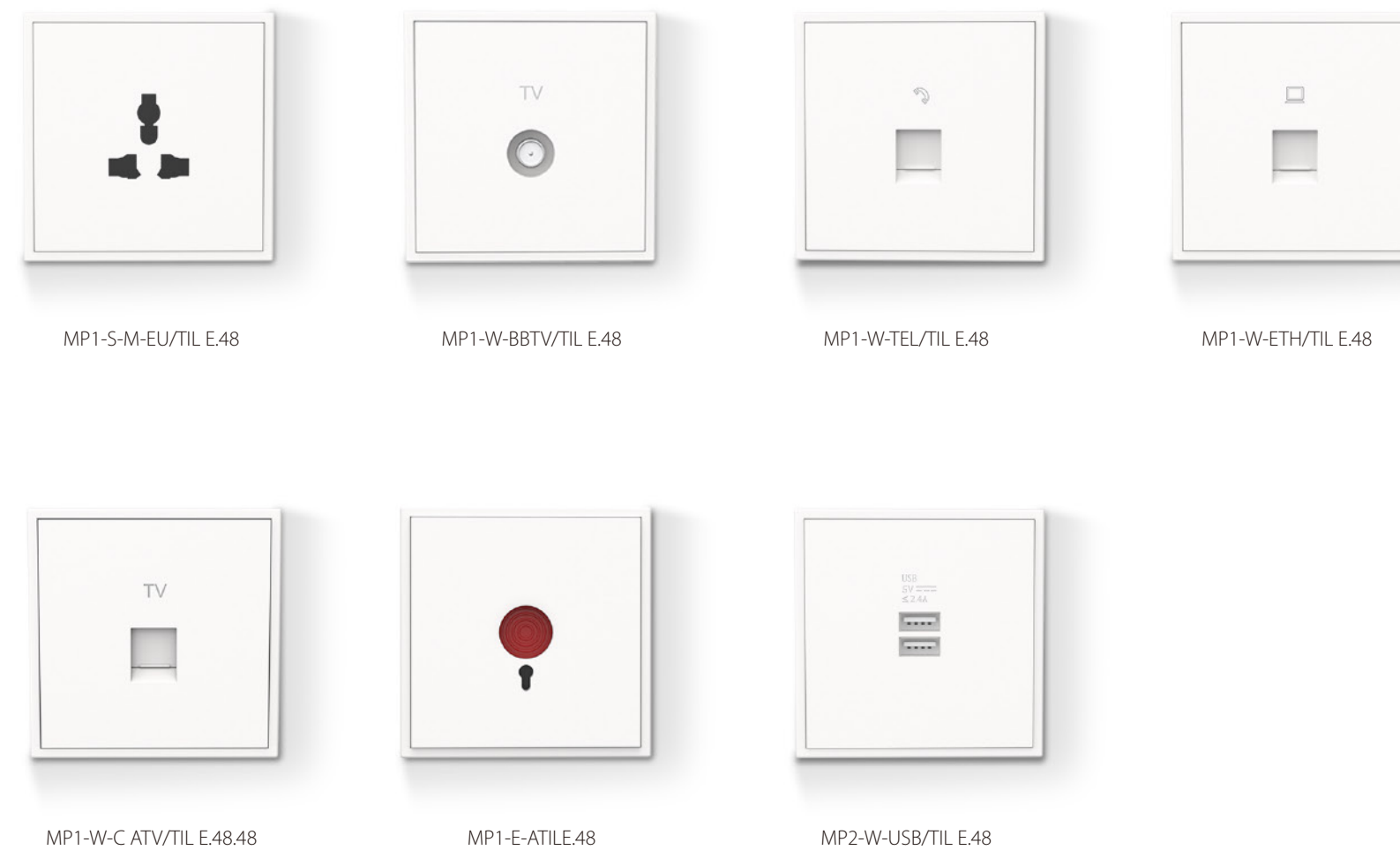
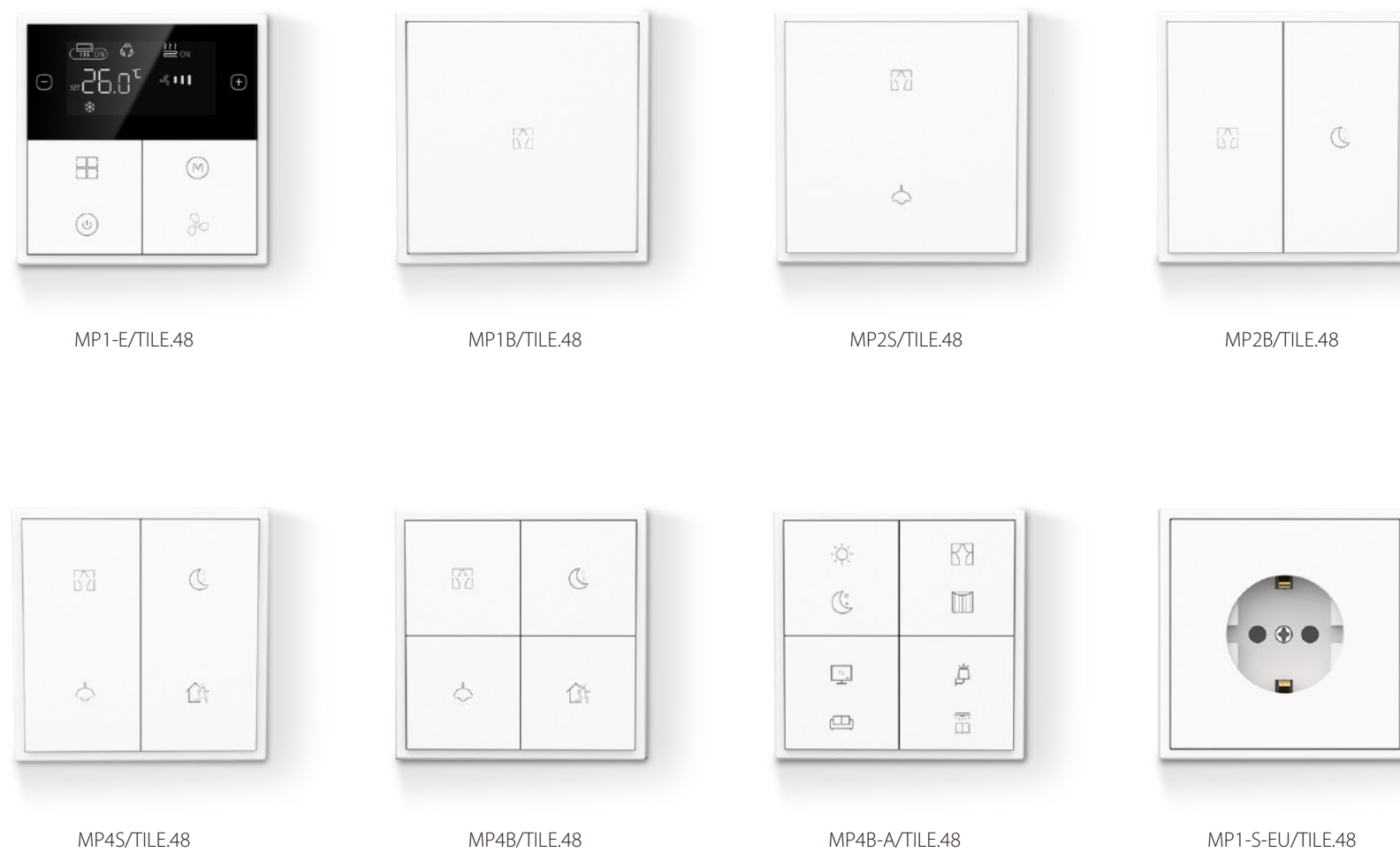

- Horizontal

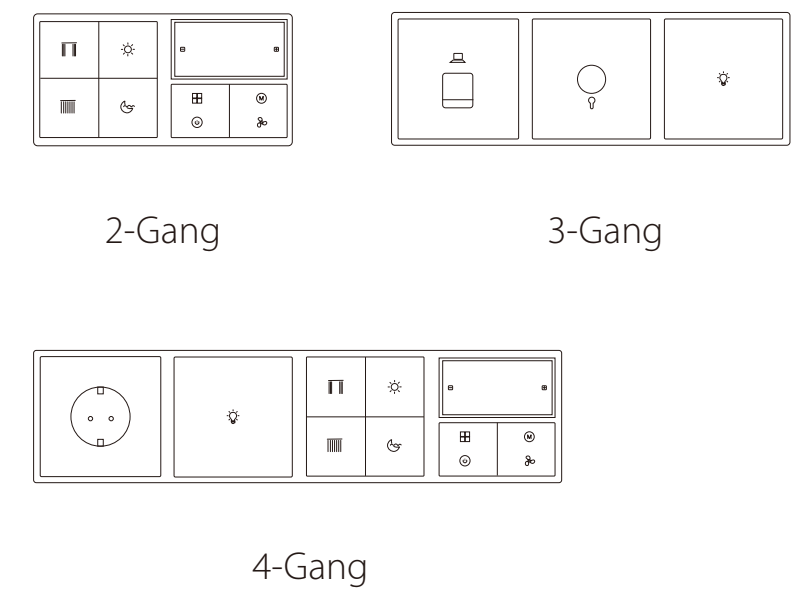

- Vertical

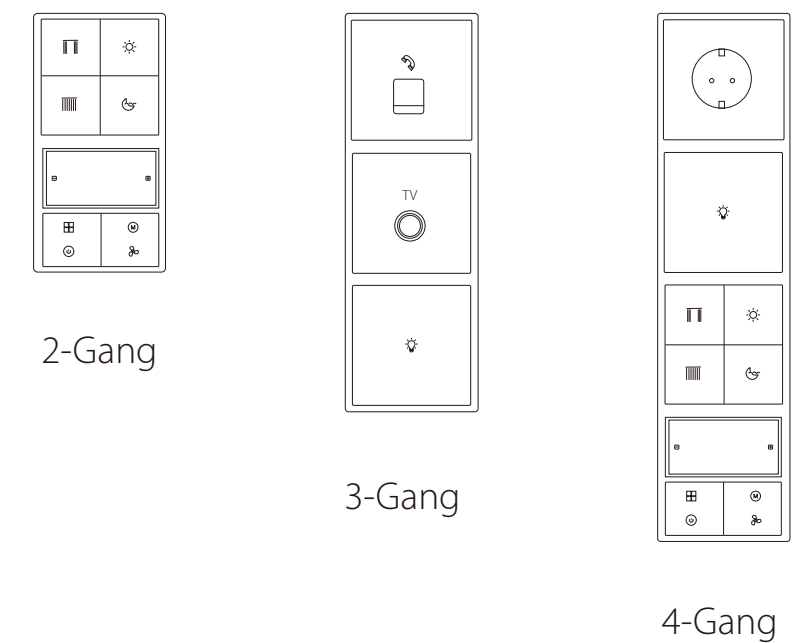

Granite SERIES

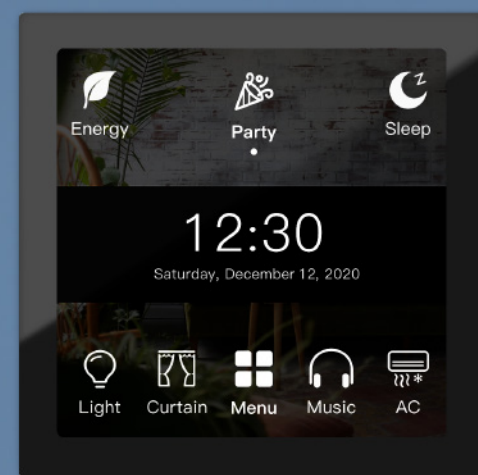

Granite Display



Granite

Granite Display is a multifunctional touch panel which can control lights, curtains, modes, HVAC, music, primary air system, etc.

Instead of installing a row of switches on the wall, you can just use one Granite Display to control all electric devices and keep the wall in a minimal look. And Granite is a push-button panel provide you with the instinctive experience. And these two panels, due to their unified appearances, can add credits to your home decoration.

Granite Display

Color: ● White ● Black

Granite

● Arctic Silver ● Space Gray ● Rose Gold



S57

S57 is a multifunctional touch-control panel with a 5.7-inch display. You can easily control every device connected to the smart system just by flipping your fingers on the screen.

Color: White Black

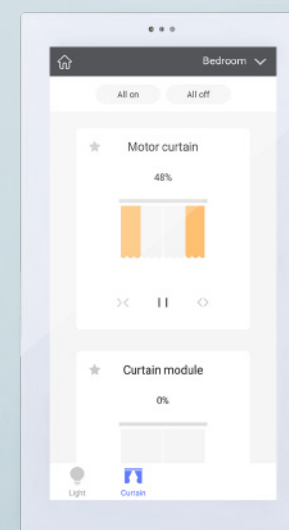

Prism Pro

Prism Pro is a touch panel that consists of an elegant metal frame and covered entirely by one piece of glass on the front. With the display showing the control targets and statuses, you can intuitively control lighting, shading, HVAC, music, and more functions.

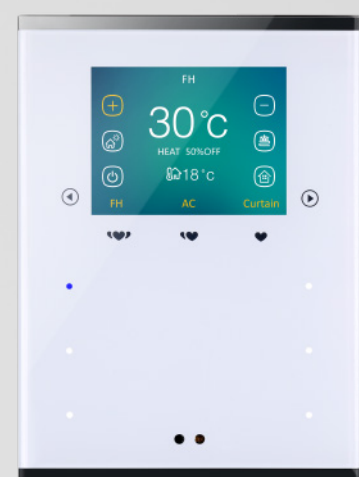

Color:

White Black



HDL®

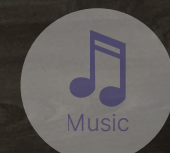

Prism Lite

Prism Lite is a smart panel that can easily control the lighting, shading, scenes, etc. Designed to be premium and simple, Prism Lite can easily merge into your interior deco with its minimal appearance.



Color: White Black



iTouch

iTouch is always a great option if you are looking for a beautiful keypad of minimal design. Its body is enclosed by a fine aluminum frame, while the face is a piece of glass with touch buttons. It perfectly matches any interior decoration.



Color: White Black



HDL®

DLP+DLP Touch

Both DLP and DLP Touch are multi-functional keypad for lighting, shading, AC control, etc. They are designed to offer you a quick and simple control experience. With the LCD display, you can have the icons or text customized. Every time you touch the panel, you clearly know what to control.

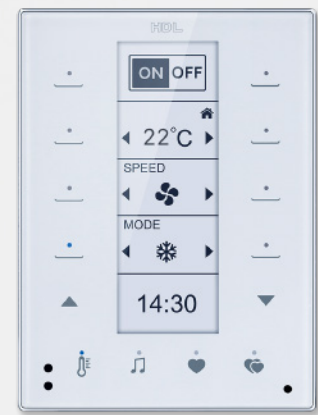

DLP Touch

Color: White Black

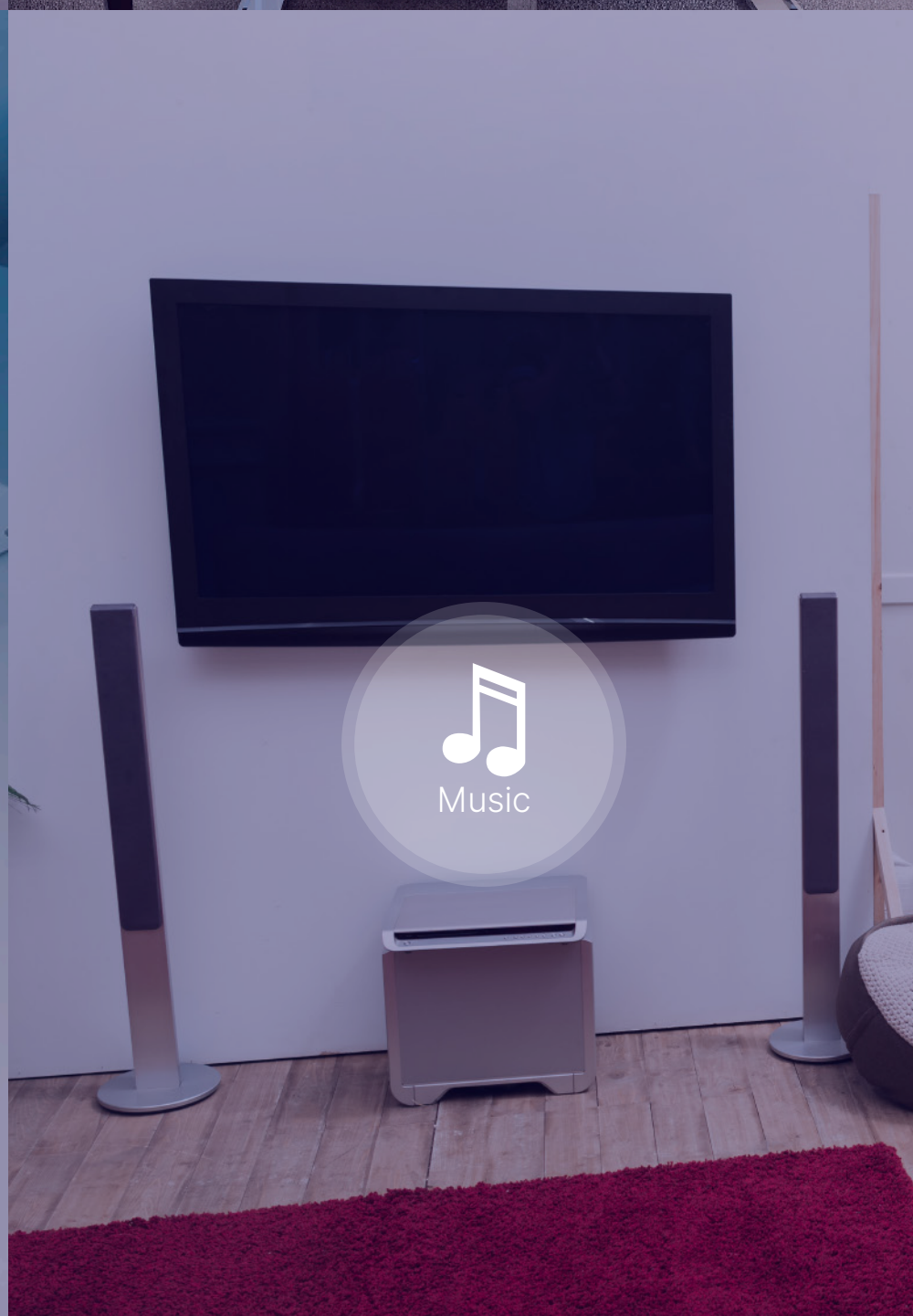
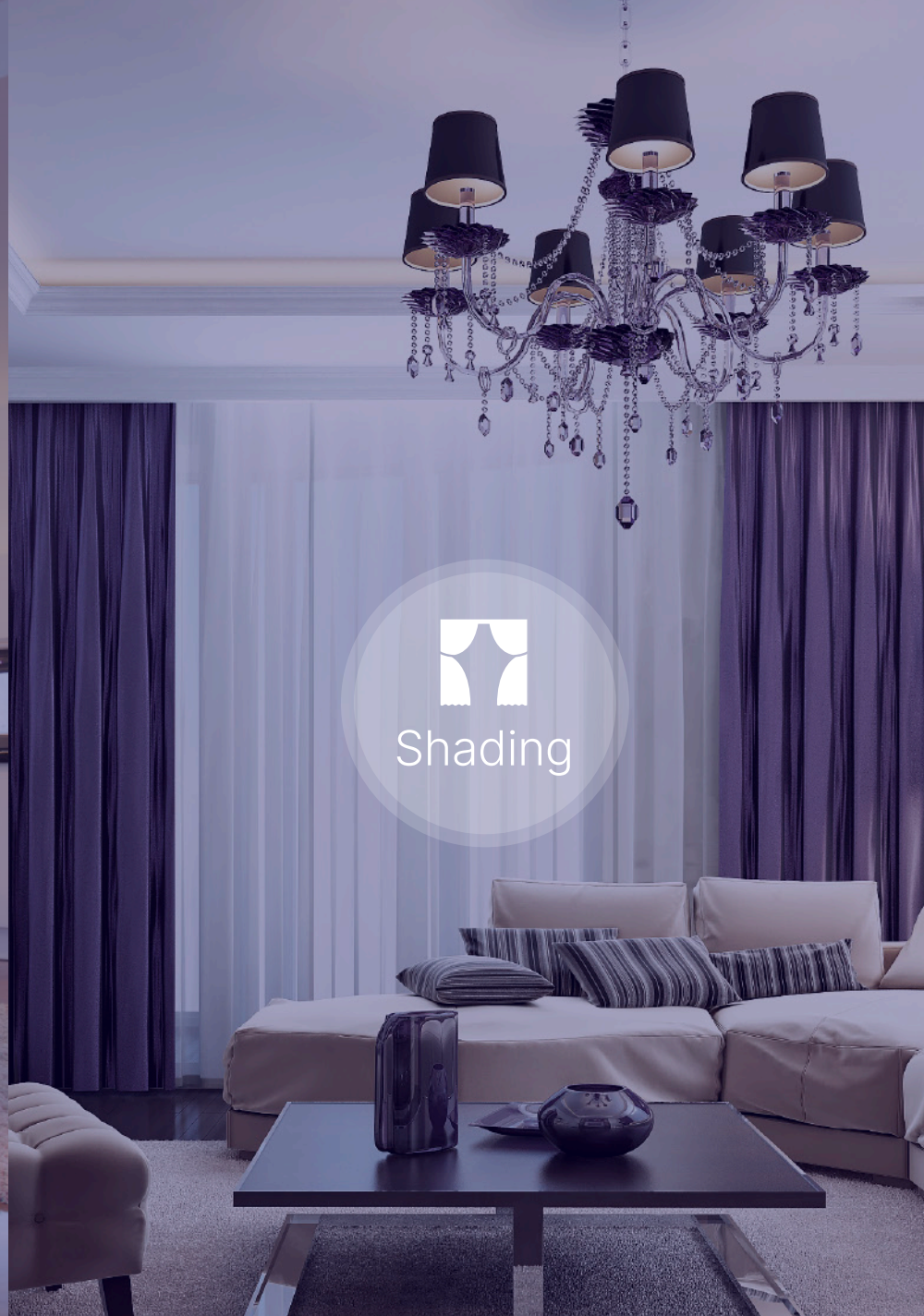

HDL®



DLP

Color:
 White
 Black

